



TECHNICAL INFORMATION

Productivity + -	110 diners
Fire up time	30 min average
Charcoal daily consumption *	15 – 17 kg
Performance*	9 h
Broiling temperature	250 °C to 350 °C
Exhaust rate	2.500 m3/h
Heat Output *	8 kw
Extraction diameter Ø	180mm

DIMENSIONS & WEIGHTS

Without packaging	968x756x1835 mm
With packaging	1070X930X1900 mm
Weight (NET)	350 kg
Weight (with packaging)	418 kg

INSTALLATION

Clearance with non-flammable equipment	100 mm
Clearance with flammable equipment	300 mm

*Depends on the charcoal quality.

INCLUDED ACCESSORIES

- 2 Stainless steel grill racks // Upper heating rack// Chimney kit// Ash pan drawer
- 1 Stainless steel tong// Grease collector tray// Grill scraper//Poker// Ash shovel

DOOR COLOURS



Black



Red



Inox

TECHNICAL DRAWINGS

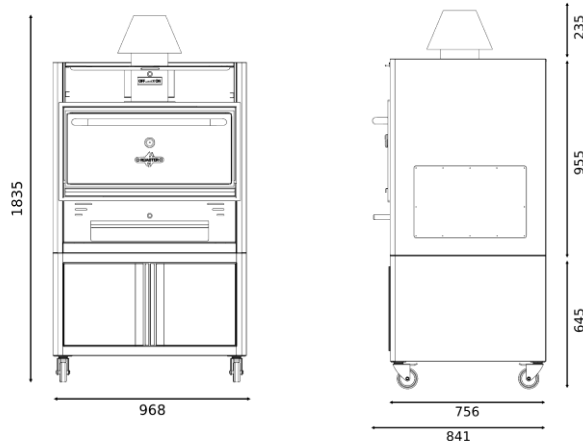
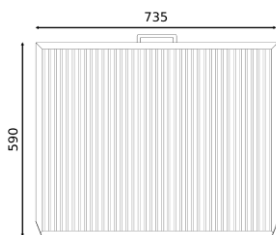
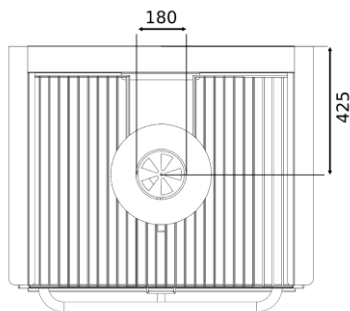

*Dimensions in mm

*The ovens are subject to technical and design changes without previous notice.

