

TECHNICAL INFORMATION

Roasting area	1000X620 mm
Fire up time	30 min average
Charcoal daily consumption*	Charcoal 18 – 22 kg
Broiling temperature	200 °C to 250 °C
Exhaust rate	2.500 m3/h

DIMENSIONS & WEIGHTS

Without packaging	1150x730x1580 mm
With packaging	1300X950X1780 mm
Weight (NET)	220 kg
Weight (with packaging)	289 kg

INSTALLATION

Clearance with non-flammable equipment	100 mm
Clearance with flammable equipment	300 mm

*Depends on the charcoal quality.

INCLUDED ACCESSORIES

1 "V" grooved removable grill rack // 2 removable upper racks // Grill scraper // Poker//
Ash pan drawer // Grease tray //Charcoal shovel // Fire bricks //Charcoal starter // Packaging

OPTIONAL ACCESSORIES

Extra "V" grills // "Z" grills // Rod grills

TECHNICAL DRAWINGS

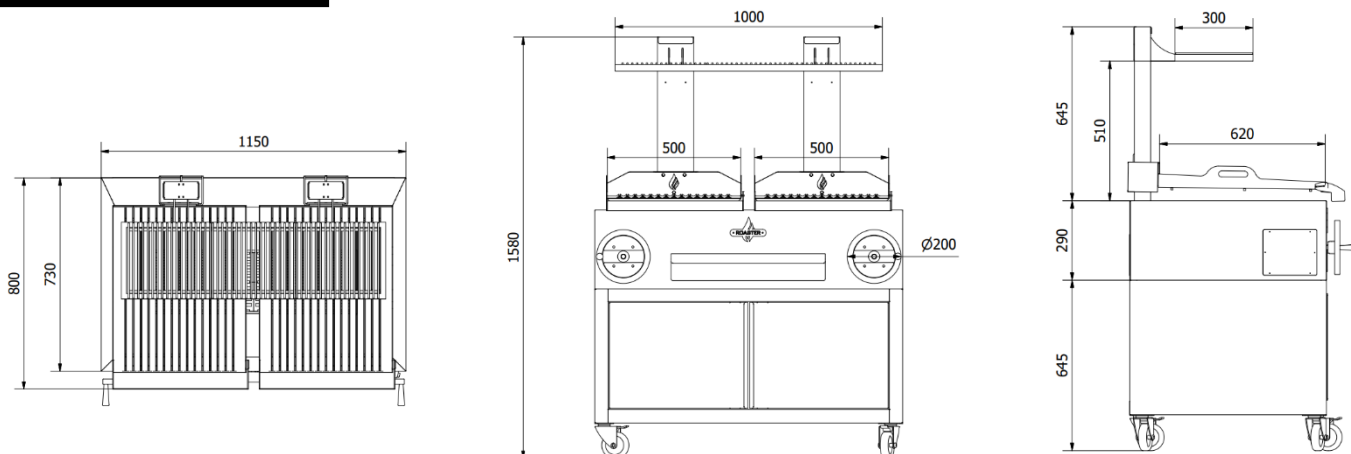

*Dimensions in mm

*The rotisseries are subject to technical and design changes without previous notice.

